

LTV[®] 1200/1150 Ventilators

Quick Reference Guide



P/N 18409-001 Rev. B

ASSISTANCE

Cardinal Health

Pulmonetic Systems

17400 Medina Rd., Suite 100

Minneapolis, Minnesota 55447-1341

Customer Care: (800) 754-1914

(763) 398-8500

Fax: (763) 398-8403

Website: www.cardinalhealth.com/viasys

TABLE OF CONTENTS

Table of Contents:

Front and Side Panel Reference	1
Front Panel Display and Description.....	1
Side Panel Descriptions.....	3
Turning the Ventilator On and Off	5
Turning the Ventilator On	5
Turning the Ventilator Off	6
LTV® 1200/1150 Preset values Table.....	7
LTV® 1200/1150 Preset Values Table (cont.).....	8
Variable Controls.....	9
SETTING UP MODES OF VENTILATION.....	11
Setting Up Assist/Control Mode.....	11
Setting Up SIMV Mode	13
Setting Up CPAP Mode	15
Setting Up NPPV Mode	17
Monitored Data	19

Extended Features	21
SBT (Spontaneous Breathing Trial)	23
Using AC/DC Power	27
Using the AC Adapter	27
Using an External DC Power Source	28
Power Displays and Indicators	29
Attaching a Breathing Circuit	32
Oxygen Computer Chart	33
Alarms	35

FRONT AND SIDE PANEL REFERENCE

Front Panel Display and Description (LTV[®] 1200 shown)

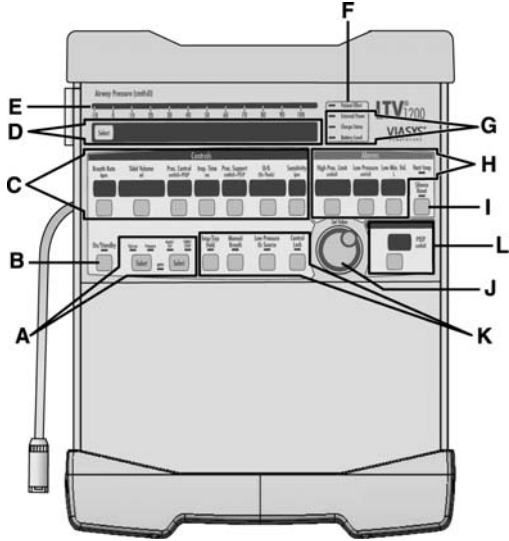

- A - **Mode and Breath Selection** – Selects ventilation modes, and selects breath types.
- B - **On/Standby Button** – Turns the ventilator “On” or to “Standby”.
- C - **Variable Control Settings** – Sets and displays each ventilation characteristic.
- D - **Display Window** – Displays Alarm Messages, Monitored Data, and Extended Features menus.
- E - **Airway Pressure Display** – Displays real-time airway circuit pressure.
- F - **Patient Effort Indicator** – LED is lit briefly each time a patient trigger is detected.
- G - **Power Source** – Displays power source and charge levels.
- H - **Variable Alarm Settings** – Sets and displays variable alarm levels.
- I - **Alarm Silence/Reset** – Silences audible alarms. Clears visual alarms.
- J - **Set Value Knob** – Changes variable control settings. Navigates Extended Features.
- K - **Special Controls** – Activates special controls such as Manual Breath, Low Pressure O₂ Source (LTV[®] 1200 only), Insp/Exp Hold and Control Lock feature.
- L - **PEEP** – PEEP control setting and display.

FRONT AND SIDE PANEL REFERENCE

Side Panel Descriptions

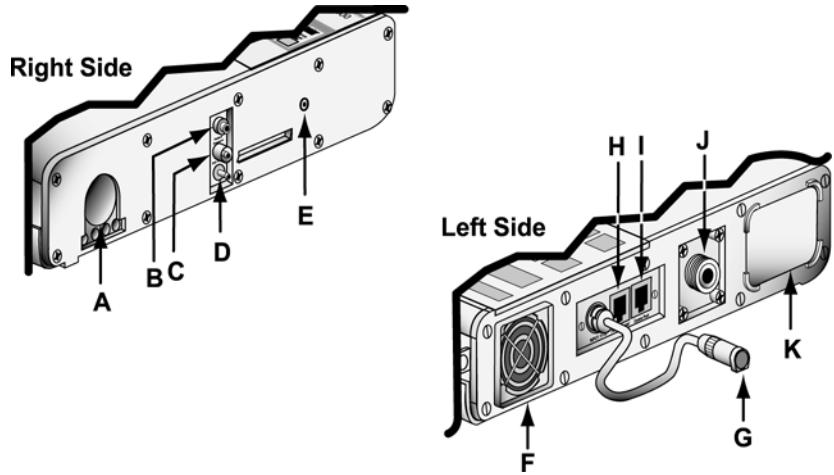

- A - **22mm Outlet Port** – Patient Breathing Circuit outlet port.
- B - **Flow Xducer** – Flow Transducer high pressure sensing port.
- C - **Flow Xducer** – Flow Transducer low pressure sensing port.
- D - **Exh Valve** – Exhalation Valve drive line port.
- E - **Alarm Sounder Port**
- F - **Cooling Fan**
- G - **DC Input** – DC power port pigtail connector.
- H - **Patient Assist** – Patient Assist Call jack.
- I - **Comm Port** – Communications port.
- J - **O₂ Inlet** – Oxygen Inlet fitting.
- K - **Filter** – Air Inlet.

TURNING THE VENTILATOR ON AND OFF

Turning the Ventilator On

On/ Standby



1) Push the **On/Standby** button.



If the Patient Query feature is enabled/on when the ventilator is powered up, ventilation and alarm activation are suspended and the message **SAME PATIENT** is displayed.

- To enable the suspended alarms and begin ventilation with the settings in use during the last power cycle, press the **Select** button while **SAME PATIENT** is displayed.
- To enable the suspended alarms and begin ventilation with Preset values appropriate for a new patient, turn the **Set Value** knob until **NEW PATIENT** is displayed and press the **Select** button. Then turn the **Set Value** knob until the desired patient type is displayed (**INFANT**, **PEDIATRIC** or **ADULT**) and press the **Select** button (see the *LTV[®] 1200 or LTV[®] 1150 Operator's Manual*, Chapter 10, for detailed settings and information).

If the Patient Query feature is disabled/off when the ventilator is powered up and passes POST, it will begin ventilation (appropriate alarms enabled) using the settings in use during the last power cycle.

Turning the Ventilator Off

To turn the ventilator off:

- 1) **Disconnect the patient from the ventilator.**
- 2) Press and hold the **On/Standby** button for 3 seconds. The ventilator ceases operating, the audible alarm sounds continuously and the **Vent Inop** LED is lit. 
- 3) Press the **Silence/Reset** button to silence the audible alarm.
 - Verify a confirming audible chirp is activated immediately after the alarm is silenced.
- 4) The ventilator continues to charge the internal battery as long as it is connected to an external power source.

Note: The **Vent Inop** LED will remain lit for a minimum of 5 minutes and does not impact battery life.

LTV® 1200/1150 PRESET VALUES TABLE

Feature/Function	Infant (>5kg < 10kg)	Pediatric (10-40 kg)	Adult (> 40 kg)
Alarm volume	85	85	85
HP delay	NO DELAY	NO DELAY	NO DELAY
LPP alarm	ALL BREATHS	ALL BREATHS	ALL BREATHS
High f alarm	80 bpm, 30 sec	60 bpm, 30 sec	40 bpm, 30 sec
High PEEP alarm	PEEP +5 cmH ₂ O	PEEP +5 cmH ₂ O	PEEP +5 cmH ₂ O
Low PEEP alarm	PEEP -3 cmH ₂ O	PEEP -3 cmH ₂ O	PEEP -3 cmH ₂ O
Rise Time	5	4	4
FLOW TERM	35%	30%	25%
TIME TERM	TERM 0.5 sec	TERM 1.0 sec	TERM 2.0 sec
PC FLOW TERM	Off	Off	Off
Leak Comp	LEAK COMP ON	LEAK COMP ON	LEAK COMP ON
Breath Rate	20 bpm	15 bpm	12 bpm
Breath type	Pressure	Pressure	Volume
Tidal Volume	50 ml	250 ml	500 ml

LTV[®] 1200/1150 Preset Values Table (cont.)

Feature/Function	Infant (>5kg < 10kg)	Pediatric (10-40 kg)	Adult (> 40 kg)
Insp. Time	0.3 sec	0.7 sec	1.0 sec
Pres. Control	15 cmH ₂ O	15 cmH ₂ O	15 cmH ₂ O
Pres. Support	10 cmH ₂ O	10 cmH ₂ O	10 cmH ₂ O
Sensitivity	2 Lpm	3 Lpm	3 Lpm
High Pres. Limit	30 cmH ₂ O	30 cmH ₂ O	40 cmH ₂ O
Low Pressure	10 cmH ₂ O	10 cmH ₂ O	10 cmH ₂ O
Low Min. Vol.	0.5 ml	1.0 ml	3.0 ml
PEEP	0 cmH ₂ O	0 cmH ₂ O	0 cmH ₂ O
Mode	Assist/Ctrl	Assist/Ctrl	Assist/Ctrl

VARIABLE CONTROLS

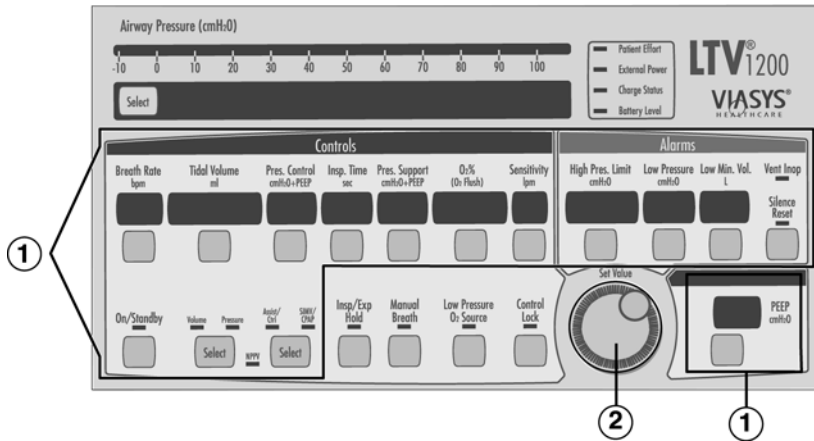

To set a variable control:

1) Select the control by pressing the associated button. The display for the selected control will be displayed at normal brightness and all other control displays will be dimmed.

2) Change the control value by rotating the **Set Value** Knob. Rotate clockwise to increase and counter-clockwise to decrease the value.



3) The new control value goes into effect when the operator:

- Presses the selected button again, or
- Selects another control, or
- Presses the **Control Lock** button, or
- Waits 5 seconds



All controls will then return to their normal brightness.

SETTING UP MODES OF VENTILATION

Setting Up Assist/Control Mode

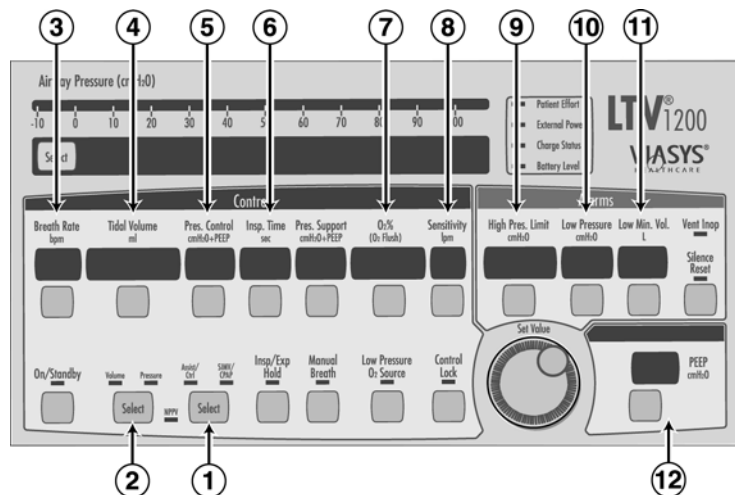

Setting Up the Ventilator in Assist/Control Mode:

- 1) Press the **Select** button twice to toggle the modes between **Assist/Control** and **SIMV/CPAP**. Select the **Assist/Control** mode.
- 2) Press the **Select** button twice to toggle between **Volume** and **Pressure** ventilation. Select **Volume** or **Pressure**, as desired.
- 3) Set the **Breath Rate**.
- 4) If **Volume** ventilation is selected, set the **Tidal Volume**. The calculated peak flow **Vcalc** is displayed in the window while Tidal Volume is being changed.
- 5) If **Pressure** ventilation is selected, set the **Pressure Control**.
- 6) Set the **Inspiratory Time**. The calculated peak flow **Vcalc** is displayed in the window while Inspiratory Time is being changed. **Vcalc** only applies to volume ventilation.
- 7) Set **O₂%** (LTV[®] 1200 only).
- 8) Set the **Sensitivity** to a setting from 1 to 9.
- 9) Set the **High Pres. Limit** alarm.
- 10) Set the **Low Pressure** alarm.
- 11) Set the **Low Min. Vol.** alarm.
- 12) Adjust the **PEEP** control.

SETTING UP MODES OF VENTILATION

Setting Up SIMV Mode

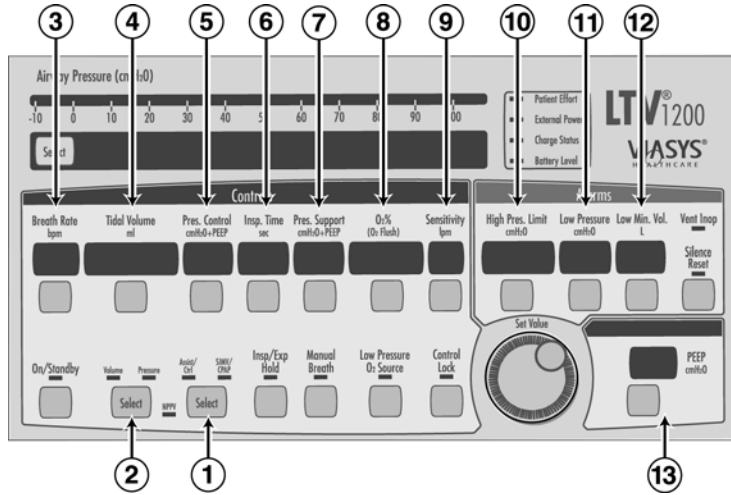

To set the Ventilator up in SIMV mode:

- 1) Press the **Select** button twice to toggle the modes between **Assist/Control** and **SIMV/CPAP**. Select the **SIMV/CPAP** mode.
- 2) Press the **Select** button to toggle between **Volume** and **Pressure** ventilation. Select **Volume** or **Pressure**, as desired.
- 3) Set the **Breath Rate**.
- 4) If **Volume** ventilation is selected, set the **Tidal Volume**. The calculated peak flow **Vcalc** is displayed in the window while Tidal Volume is being changed.
- 5) If **Pressure** ventilation is selected, set the **Pressure Control**.
- 6) Set the **Inspiratory Time**. The calculated peak flow **Vcalc** is displayed in the window while Inspiratory Time is being changed. **Vcalc** only applies to volume ventilation.
- 7) Set the **Pressure Support**, if desired.
- 8) Set **O₂%** (LTV[®] 1200 only).
- 9) Set the **Sensitivity** to a setting from 1 to 9.
- 10) Set the **High Pres. Limit** alarm.
- 11) Set the **Low Pressure** alarm.
- 12) Set the **Low Min. Vol.** alarm.
- 13) Adjust the **PEEP** control.

SETTING UP MODES OF VENTILATION

Setting Up CPAP Mode

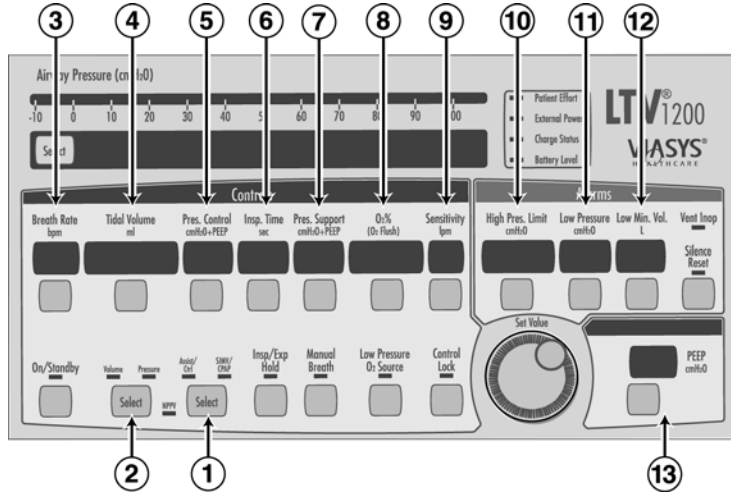

To set the ventilator up in CPAP mode:

- 1) Press the **Select** button twice to toggle the modes between **Assist/Control** and **SIMV/CPAP**. Select the **SIMV/CPAP** mode.
- 2) Press the **Select** button twice to toggle between **Volume** and **Pressure** ventilation for Apnea backup. Select **Volume** or **Pressure** for Apnea backup.
- 3) Set the **Breath Rate** to Off (dashes “- -”).
- 4) If **Volume** ventilation is selected, set the **Tidal Volume** for Apnea backup. The calculated peak flow **Vcalc** is displayed in the window while Tidal Volume is being changed.
- 5) If **Pressure** ventilation is selected, set the **Pressure Control** for Apnea backup.
- 6) Set the **Inspiratory Time** for Apnea backup. The calculated peak flow **Vcalc** is displayed in the window while Inspiratory Time is being changed. **Vcalc** only applies to volume ventilation.
- 7) Set the **Pressure Support**, if desired.
- 8) Set **O₂%** (LTV[®] 1200 only).
- 9) Set the **Sensitivity** to a setting from 1 to 9.
- 10) Set the **High Pres. Limit** alarm.
- 11) Set the **Low Pressure** alarm for Apnea backup.
- 12) Set the **Low Min. Vol.** alarm.
- 13) Adjust the **PEEP** control.

SETTING UP MODES OF VENTILATION

Setting Up NPPV Mode

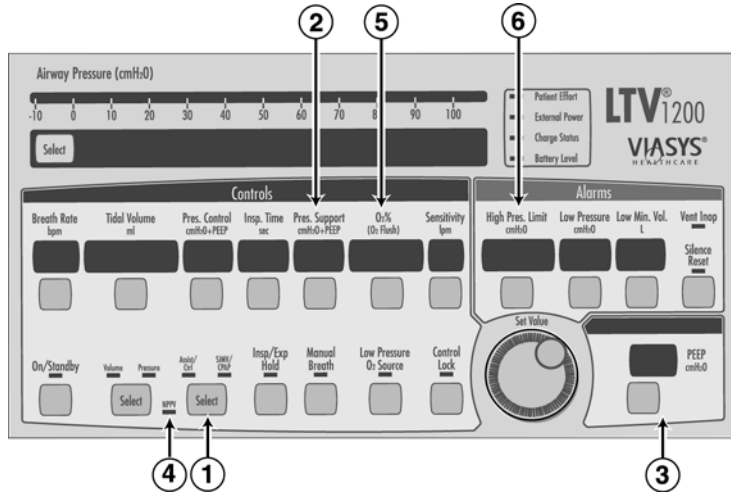

To set the Ventilator up in NPPV mode:

Set any desired Extended Features options and:

- 1) Push the **Assist/Control, SIMV/CPAP** mode button until the **NPPV** LED flashes. Press the button once more to confirm. The **NPPV** LED continues to flash and **SET IPAP** displays. The **Pres. Support** control display is bright and all other controls dim.
- 2) Turn the **Set Value** knob to adjust the IPAP value (shown in **Pres. Support** LED window). Press the **Pres. Support** button to confirm, **SET EPAP** will display. The **PEEP** control display is bright and all other controls are dim.
- 3) Turn the **Set Value** knob to adjust the EPAP value (shown in the **PEEP** LED window). Press the **PEEP** button to confirm.
- 4) The **PEEP** button push confirms **NPPV** operation and LED then turns solid.
- 5) Set **O₂%** (LTV[®] 1200 only).
- 6) Set the **High Pres. Limit** alarm.

MONITORED DATA

The monitored data displays may be automatically scrolled or manually scrolled. To cycle through the available monitored data automatically from a halted scan, press the Monitor **Select** button (left of display window) twice. Pressing the **Select** button once while scan is active shall halt scanning and the currently display monitor shall remain in the display window. Each time you press the button once; the next data item in the list will be displayed. To resume scan, press the **Select** button twice within 0.3 seconds. The monitored data is displayed in the following order:

Display	Description
PIP	Displays the Peak Inspiratory Pressure measured during the inspiratory phase. PIP is not updated for spontaneous breaths.
MAP	Displays a running average of the airway pressure for the last 60 seconds.
PEEP	Displays the pressure in the airway circuit at the end of exhalation.
f	Displays the breaths per minute and includes all breath types.
Vte	Displays the exhaled tidal volume as measured at the patient wye.
VE	Displays the exhaled tidal volume for the last 60 seconds as calculated from the last 8 breaths.

Display	Description
I:E	Displays the ratio between measured inspiratory time and measured exhalation time. Both normal and inverse I:E Ratios are displayed.
I:Ecalc	Displays the ratio between the set Breath Rate and Inspiratory Time. The display is updated in real-time while the Breath Rate setting is being changed.
Vcalc	Is based on the Tidal Volume and Inspiratory Time settings. Displayed when selected and whenever Tidal Volume or Inspiratory Time is selected for change.
SBT min	Displays the time remaining until the number of minutes preset in the SBT OP, MINUTES menu have elapsed. (Only displayed in the SBT mode of ventilation.)
f/Vt f	f/Vt is computed every time the Total Breath Rate (f) or Total Minute Volume (VE) is calculated. (Only displayed when SBT mode is selected.)

EXTENDED FEATURES

Navigating the Extended Features Menus:

To enter the **Extended Features menu** (in normal ventilation mode), press and hold the Monitor **Select** button for three seconds.



To view the next item in a menu, turn the **Set Value** knob clockwise.



To view the previous item, turn the **Set Value** knob counterclockwise.



To enter a menu item or select a setting, press the **Select** button.



To exit a menu, turn the **Set Value** knob until the **EXIT** option is displayed, then press the **Select** button or press **Control Lock**.

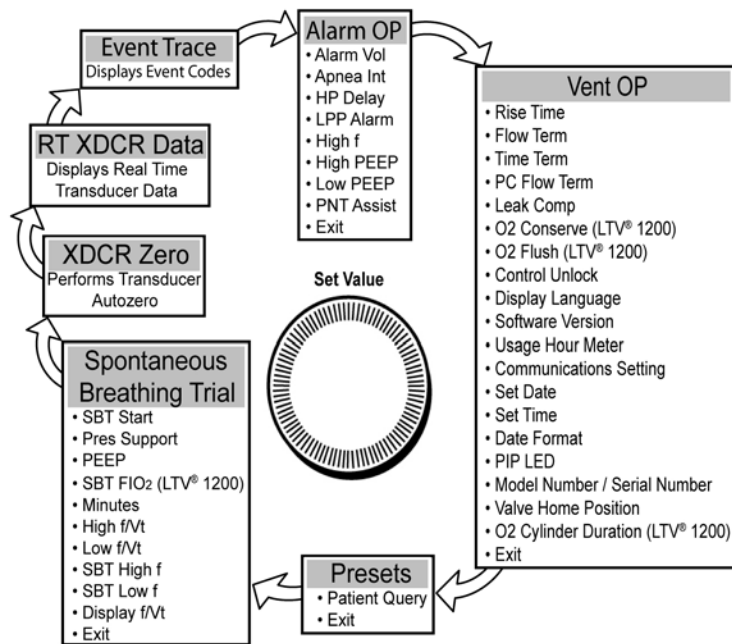

EXTENDED FEATURES

SBT (Spontaneous Breathing Trial)

Using the Spontaneous Breathing Trial option you can temporarily minimize ventilatory support and perform clinical assessments of a patient's dependence on, or ability to be removed from positive pressure ventilation. SBT mode should be used only while attended by a Respiratory Therapist or other properly trained and qualified personnel (please refer to the *LTV[®] 1200 or LTV[®] 1150 Operator's Manual*, Chapter 10, for more information).

When the Spontaneous Breathing Trial mode is turned on (SBT ON selected);

- The ventilator switches to CPAP mode.
- Pressure Support and FiO₂ control settings on the front panel are overridden with the values preset in the SBT OP menus.
- The High Breath Rate alarm (**HIGH f**) in the **ALARM OP** menu is disabled (as long as the SBT mode is on).

EXTENDED FEATURES

SBT (Spontaneous Breathing Trial)

To modify the Spontaneous Breathing Trial settings:

- 1) Turn the **Set Value** knob until **SBT START** is displayed, push the **Select** button, and **SBT OFF** or **SBT ON** is displayed.

Turn the **Set Value** knob until the desired setting is displayed, and push the **Select** button.



- When **SBT ON** is selected, the Spontaneous Breathing Trial ventilation mode is turned on using the current SBT menu settings. If the SBT menu settings were not previously reset, the factory set default settings will be used. **All SBT menu settings are to be reviewed for applicability and/or set as necessary, prior to selecting the SBT ON menu option.**
- When the Spontaneous Breathing Trial ventilation mode is active and **SBT OFF** is selected, the Spontaneous Breathing Trial ventilation mode is terminated and ventilation returns to the previously set modes/settings.

SBT (Spontaneous Breathing Trial)

2) SBT Menu Options

SBT OP

SBT START
PRES SUPPORT
PEEP
SBT FIO2 (LTV[®] 1200 only)
MINUTES
HIGH f/Vt
LOW f/Vt
SBT HIGH f
SBT LOW f
DISPLAY f/Vt
EXIT

Turn the **Set Value** knob until desired SBT menu option is displayed, push the **Select** button and the value setting is displayed.

Turn the **Set Value** knob until the desired setting is displayed, push the **Select** button, and the desired value is set.

EXTENDED FEATURES

Exiting Extended Features

To return to Monitored Parameters:

1) Turn the **Set Value** knob until **EXIT** is displayed.



2) Press the **Select** button.



3) Repeat Steps 1 and 2 until the Monitored Parameters are displayed.

USING AC/DC POWER

Using the AC Adapter

To run the ventilator from an external AC power source.

- 1) Connect the power jack (straight or 90°) from the AC adapter to the power port pigtail connector on the left side of the ventilator.
- 2) Connect the proper AC power cable (110 or 220 V plug) to the AC power adapter.
- 3) Connect the 110 or 220 V power cable to a suitable power source.

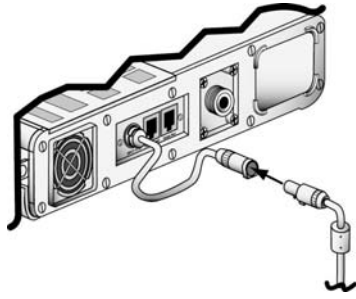

While the ventilator is plugged in, the internal battery is continuously charged.

CAUTION: Release Button – To avoid damaging the ventilator or the power connector, press the release button on the connector before removing it from the ventilator power port pigtail connector.

Using an External DC Power Source

To run the ventilator from an external DC power source.

- 1) Connect the power port of the external DC power adapter cable to the power port pigtail connector on the left side of the ventilator.
- 2) If applicable, connect the DC jack to the DC power source.

POWER DISPLAYS AND INDICATORS

Indicators

Battery Level 

The Battery Level indicator shows the level of available internal battery power while running from the internal battery.

LED Color	Battery Level	Approximate Battery Time @ nominal settings
Green	Internal battery level is acceptable	45 minutes
Amber	Internal battery level is low	10 minutes
Red	Internal battery level is critically low	5 minutes
Off	Ventilator is running on AC or External Battery	

Indicators

Charge Status

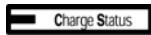

When the ventilator is plugged into an External Power source, it automatically charges the internal battery.

LED Color	Charge Status
Flashing Amber	The ventilator is performing pre-charge qualification testing of the battery prior to starting the charge process. This happens when external power is first applied to the ventilator. The qualification process normally takes a few seconds but may take up to an hour on a deeply discharged battery.
Green	The internal battery is charged to full level.
Amber	The battery has not reached a full charge level and is still charging.
Red	The ventilator has detected a charge fault or internal battery fault. The internal battery cannot be charged. Contact a Pulmonetic Systems Certified Service Technician.

POWER DISPLAYS AND INDICATORS

Indicators

External Power



The External Power indicator shows the level of external power while the ventilator is operating from an external power source. When the ventilator is running from the internal battery, the External Power indicator is off. When running from external power, the indicator shows the following levels.

LED Color	Power Level
Green	External Power level is acceptable
Amber	External Power level is low

External power may be provided by connecting the ventilator to an external battery or to an external AC power source.

ATTACHING A BREATHING CIRCUIT

How to attach a Patient Breathing Circuit.

- 1) Connect the main breathing tube to the 22 mm outlet port on the right side of the ventilator.
- 2) Connect the two exhalation flow transducer sense lines to the ports marked **Flow Xducer** on the right side of the ventilator. These are non-interchangeable Luer fittings.
- 3) Connect the Exhalation Valve driver line to the port marked **Exh Valve** on the right side of the ventilator.

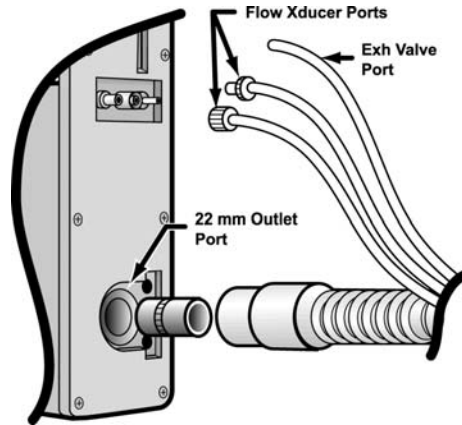

OXYGEN COMPUTER CHART

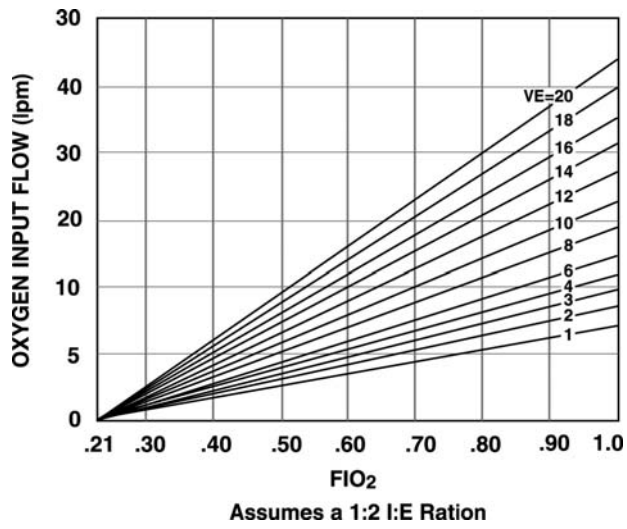

Oxygen Computer Chart

To determine O₂ Input Flow:

- 1) Find the desired FiO₂ on the horizontal axis.
- 2) Project up to the minute volume.
- 3) Project horizontally to the left vertical axis and read the oxygen flow.

To determine O₂ Concentration:

- 1) Find the O₂ input flow on the vertical axis.
- 2) Project horizontally right to the minute volume.
- 3) Project vertically down to the horizontal axis and read the FiO₂.

ALARMS

How to Silence and Reset Alarms

To silence an alarm, press the **Silence Reset** button.

To reset an alarm that has been corrected, press the **Silence Reset** button again.



Alarm	Cause	Solution
APNEA XX bpm	Occurs when the time since the last breath start exceeds the set Apnea Interval. When an Apnea alarm occurs, the ventilator will enter Apnea Back up ventilation mode.	Reevaluate the patient's condition. Reevaluate ventilator settings.
APNEA	An Apnea alarm has occurred and cleared The ventilator is no longer in Apnea Back-up mode.	Reevaluate the patient's condition. Reevaluate ventilator settings.

Alarm	Cause	Solution
BAT EMPTY	Occurs when the ventilator is operating from the internal battery power and the batter charge level is critically low. This alarm can be temporarily silenced but cannot be cleared.	Attach the ventilator to external AC or DC power.
BAT LOW	Occurs when the ventilator is operating from internal battery power and the battery charge level is low.	Attach the ventilator to external AC or DC power. Reevaluate power requirements.
DEFAULTS	Occurs during POST when the ventilator detects an invalid setting stored in non-volatile memory.	Push the Silence/Reset button twice to reset alarm. Reevaluate ventilator settings.
DEFAULTS SET	Occurs when the ventilator is first powered up after the SET DEFAULTS option has been used to reset all controls and extended features settings to their factory-set default values.	Push the Silence/Reset button twice to reset alarm. Reevaluate ventilator settings.

Alarms

Alarm	Cause	Solution
DISC/SENSE	Occurs when the ventilator detects one of the following conditions: <ul style="list-style-type: none">• The patient circuit or proximal pressure sense line has become disconnected.• The low side exhalation flow transducer sense line has become disconnected.• The proximal pressure sense line is pinched or occluded.	Check Patient Circuit assembly for disconnects. Check pressure sensing lines for occlusions.
HIGH f	Occurs when the Total Breath Rate (f) exceeds the high breath rate and time period alarm values.	Check Patient Circuit assembly for leaks. Check HIGH f alarm values.
HIGH O₂ PRES (LTV [®] 1200 only)	Occurs when the average oxygen inlet pressure exceeds the acceptable limit for the type of oxygen source.	Reduce O ₂ inlet pressure.

Alarm	Cause	Solution
HIGH PEEP	Occurs when the ventilator detects one of the following conditions: <ul style="list-style-type: none"> • The patient circuit positive end expiratory pressure (PEEP) exceeds the High PEEP alarm setting. • Patient Circuit, Exhalation valve and/or PEEP valve occluded. 	Reevaluate ventilator settings. Disassemble, clean and reassemble the Patient Circuit, Exhalation Valve and PEEP Valve.
HIGH PRES	Occurs when the circuit pressure exceeds the set High Pressure Limit setting.	Reevaluate ventilator settings. Inspect Patient Circuit for occlusions or kinks. Reevaluate patient.
HW Fault	Occurs when the ventilator detects a problem with the ventilator hardware.	If alarm reoccurs, contact your Service Rep or Pulmonetic Systems.

Alarms

Alarm	Cause	Solution
INOP Vent Inop ■	A ventilator INOP occurs when: <ul style="list-style-type: none">• The ventilator is switched from On to Standby.• The ventilator detects any condition that is deemed to make the ventilator unsafe.	If an INOP alarm occurs during operation, remove ventilator from service and contact your Service Rep.
LOCKED	The LOCKED message is displayed when a button is pressed while the controls are locked. No audible alarm is given.	Press the Control Lock button. If locked alert continues, press and hold the Control Lock button for three seconds.
LOW MIN VOL	Occurs when the exhaled minute volume is less than the set Low Minute Volume.	Examine Exhalation Valve body for disconnects. Reevaluate patient.

Alarm	Cause	Solution
LOW O₂ PRES (LTV [®] 1200 only)	Occurs when the average oxygen inlet pressure is less than the minimum acceptable inlet pressure of 35 PSIG.	Increase O ₂ inlet pressure. If using O ₂ cylinder, replace used cylinder with a new one.
LOW PEEP	Occurs when the patient circuit Positive End Expiratory Pressure (PEEP) is less than the Low PEEP alarm setting.	Reevaluate ventilator settings. Disassemble, clean and reassemble the Patient Circuit, Exhalation Valve and PEEP Valve.
LOW PRES	Occurs when the peak inspiratory pressure for a machine or assist breath is less than the Low Pressure setting.	Examine Patient Circuit for disconnect. Reevaluate ventilator settings. Reevaluate patient.
NO CAL DATA, NO CAL	Occurs when the ventilator detects invalid or missing calibration records on power up.	Remove ventilator from service, perform Calibration procedure.

Alarms

Alarm	Cause	Solution
POWER LOST	Occurs when the ventilator is operating on external power and the voltage drops below the useable level and switches to internal battery operation.	Evaluate power requirements. Attach ventilator to an external AC or DC power source.
POWER LOW	Occurs when the ventilator is operating on external power and the voltage drops to the low level.	Evaluate power requirements.
REMOVE PTNT	Occurs when the ventilator is powered up in the Ventilator Checkout or Ventilator Maintenance modes. The ventilator is not delivering gas.	Ensure patient is disconnected from ventilator and is being ventilated by alternative means.

Alarm	Cause	Solution
RESET	A RESET alarm occurs if the ventilator restarts following a condition other than being shut down by pressing the On/Standby button.	May be caused by Internal Battery depletion or ESD. If the problem reoccurs, remove from service and contact your Service Rep or Pulmonetic Systems
SBT < f SBT > f SBT < f/Vt SBT > f/Vt SBT OFF	These alarms are only active in the Spontaneous Breathing Trial (SBT) mode of ventilation (see the <i>LTV[®] 1200</i> or <i>LTV[®] 1150 Operator's Manual</i> , Chapter 9, for more information on each alarm setting).	
XDCR FAULT	Occurs when a transducer autozero test fails.	Press Silence/Reset button twice to reset alarm. If problem occurs frequently, remove from service and contact your Service Rep. or Pulmonetic Systems.

Cardinal Health
Pulmonetic Systems
17400 Medina Rd., Suite 100
Minneapolis, Minnesota 55447-1341

Customer Care: (800) 754-1914
(763) 398-8500
Fax: (763) 398-8403

www.cardinalhealth.com/viasys

